





## Experience Rhythm...

.....

This green wall transcends imitation, presenting a disciplined interplay of geometry, color, and texture – designed with precision yet rooted in nature. Its lattice framework transforms repetition into rhythm, structure into vitality. More than ornament, it is a spatial intervention that reshapes atmosphere with clarity and cultivated naturalism



# Why Preserved Moss?

Preserved moss walls bring the richness of nature indoors while performing as natural acoustic absorbers. With no need for watering, light, or trimming, they deliver lasting greenery at minimal cost. Their porous texture softens sound and improves comfort, while their preserved state ensures long-term sustainability by eliminating ongoing resource use.

## PRESERVED FROM NATURAL STATE



It captures the rich, lifelike texture and vibrant tones of live moss, yet it remains beautifully stable

- + Stability and Longevity
- + Natural Aesthetic
- + It retains its appearance for years if kept dry and away from direct sun.

## TACTILE



Soft, velvety, and natural to the touch — inviting a sensory connection with nature indoors.

- + Authentic Texture
- + Comforting touch
- + Durable Feel

## ACOUSTIC



The organic, fibrous structure of helps diffuse and absorb ambient noise.

- + Sound Absorption
- + Acoustic Comfort
- + Biophilic Acoustics

## SUSTAINABLE



Aligns with Sustainable Design Frameworks

- + Resource Efficient
- + Eco-Friendly Sourcing
- + LEED and WELL Contributions

## MAINTENANCE FREE



Delivering a Lush, Natural Aesthetic, eliminating operational Cost and Complexity.

- + Zero Irrigation
- + Sunlight Independent
- + Low OPEX Advantage

## LEED POINTS

# +4

By being Maintenance-Free, Resource-Efficient and Biophilic, supports LEED v4 credit Pathways

- + Low-emitting Materials
- + Sourcing of Raw Materials
- + IEQ (Indoor Environmental Quality)
- + SS Sustainable Sites

## FIRE RESISTANCE



Added fire-resistant treatments, they complies with interior building codes, ensuring that biophilic design does not compromise safety.

- + Tested and Certified
- + Safety Integration
- + Design Confidence

## EXPERIENTIAL







Attachment solution using physical hardware to attach to an existing surface or substrate.

- + Multi-Sensory Engagement
- + Emotional Resonance
- + Place-Making Power

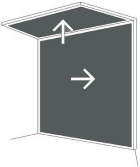
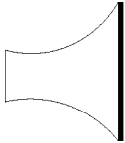
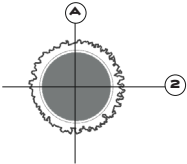
# Multiple Spatial Possibilities

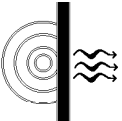
Preserved moss walls bring the richness of nature indoors while performing as natural acoustic absorbers. With no need for watering, light, or trimming, they deliver lasting greenery at minimal cost. Their porous texture softens sound and improves comfort, while their preserved state ensures long-term sustainability by eliminating ongoing resource use.

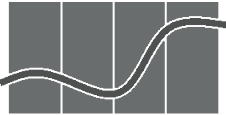
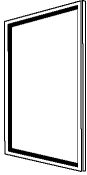
<p><b>CEILING AND WALLS</b></p>  <p>As architecture specialties, moss adds texture, calm, and acoustic comfort</p> <ul style="list-style-type: none"> <li>+ Specialty wall finishes with acoustic absorption</li> <li>+ Distinctive overhead finish for spatial identity</li> </ul>	<p><b>CURVED SUBSTRATES</b></p>  <p>Flexible specialty finish that combines organic texture with spatial fluidity.</p> <ul style="list-style-type: none"> <li>+ Flex-mounting systems for concave/convex forms</li> <li>+ Creates sculptural surfaces that enhance spatial identity and user experience</li> </ul>	<p><b>COLUMN WRAP</b></p>  <p>Preserved moss column wraps turn structural elements into living-like design features</p> <ul style="list-style-type: none"> <li>+ Seamless 360° coverage with natural texture</li> <li>+ Enhances wayfinding and spatial rhythm with organic presence</li> </ul>	<p><b>LIGHTING INTEGRATION</b></p>  <p>Elevates surfaces into immersive architectural features.</p> <ul style="list-style-type: none"> <li>+ Enhances depth, shadow, and texture</li> <li>+ Compatible with LV and specialty LED systems</li> </ul>
<p><b>ACOUSTIC BUFFERS</b></p>  <p>As panels are mounted, gaps or coves are detailed to optimize noise absorption</p> <ul style="list-style-type: none"> <li>+ Airspace behind, enhances absorption through depth and resonance.</li> <li>+ Reveals between panels act as sound traps, diffusing and buffering noise</li> </ul>	<p><b>SIGNAGE</b></p>  <p>Turns branding and into living-like architectural features, combining identity with biophilic presence.</p> <ul style="list-style-type: none"> <li>+ Cut-Out Lettering</li> <li>+ Lighting &amp; Depth Integration</li> <li>+ Enhances visibility while emphasizing moss texture.</li> </ul>	<p><b>WOOD &amp; METAL BEAVEL INTEGRATION</b></p>  <p>Bevel frames natural textures with architectural sharpness, creating refined transitions and functional edges.</p> <ul style="list-style-type: none"> <li>+ Crisp durable edges and transitions</li> <li>+ Functional Detailing</li> </ul>	<p><b>FRAMING</b></p>  <ul style="list-style-type: none"> <li>+ Wood framing paired with preserved moss transforms installations into architectural art pieces</li> <li>+ Architectural borders</li> <li>+ Durability and Craft</li> </ul>

# Care Guidelines

---

**Nature – beautifully preserved, effortlessly maintained.**

Plantscape Preserved Moss is a 100% natural material, carefully preserved to retain its color, softness, and organic texture – without watering, trimming, or ongoing maintenance. With proper indoor conditions, your moss installation will remain beautiful for years

## How Preserved Moss Performs

---

**+ No Water Required**

Preserved moss is not alive and should never be watered or misted.

**+ Comfortable Indoor Environments**

**+ Indoor Use Only**

Designed exclusively for interior applications, away from exterior exposure.

**Touch and Interaction**

+ Enjoy visually – avoid frequent handling

+ Natural oils from hands may affect texture and coloration over time

## Temperature

---

**+ Recommended range: 60°F – 77°F**  
(15°C – 25°C)

**+ Avoid prolonged exposure to:**

+ Extreme heat

+ Freezing conditions

+ Direct heat sources (heaters, fire places, mechanical rooms)

## Humidity

---

**+ Ideal relative humidity: 50% – 55%**

**Conditions to avoid:**

+ **Low humidity** (below 40%) – may cause moss to feel dry or brittle

+ **High humidity** (above 60%) – may lead to softness loss, dye migration, or mold risk

**Best Practice**

Preserved moss performs best in spaces that feel comfortable to people. If a space is comfortable for occupants, it is generally ideal for preserved moss

## Designed for Lasting Beauty

Preserved moss offers the look and feel of nature, without the maintenance of living plants – making it ideal for workplaces, hospitality, healthcare, and residential interiors seeking calm, biophilic design.

## Preserved Moss Materiality Options and Understanding

### Reindeer Moss - PMC#RD01LG

Preserved Reindeer Moss combines natural beauty, acoustic benefits, and sustainability for modern interiors. Its soft texture and vibrant colors evoke Nordic landscapes while remaining maintenance-free. Responsibly harvested and eco-preserved, it supports green-building goals and offers a timeless biophilic aesthetic without the upkeep of living walls

---

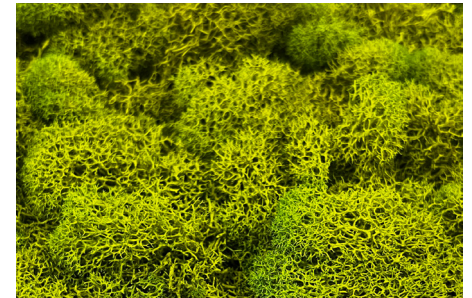

## Preserved Moss Materiality Options

### Pole Moss - PMC#PL01LG

A Preserved Pole Moss panel creates a sculptural focal point with rounded, cushion-like forms that add depth, texture, and shadow play. Beyond its bold visual impact, it enhances acoustics, making it ideal for reception areas, hospitality spaces, and branded interiors that celebrate nature's sculptural beauty

---



## Preserved Moss Materiality Options

### Sheet Moss - PMC#ST01GR

A Preserved Sheet Moss panel offers a smooth, velvety surface that evokes the forest floor with subtle tonal depth. Its continuous texture creates a serene, timeless backdrop while enhancing acoustics. Ideal for minimalist feature walls or refined settings, it delivers understated elegance and biophilic presence.

.....



## Preserved Moss Materiality Options

### Mood Moss - PMC#MD01NG

A Preserved Mood Moss panel adds dramatic depth and softness with its rich, dimensional texture. Both visually striking and acoustically effective, it creates a bold biophilic statement – ideal for hospitality, wellness, or corporate feature walls where atmosphere and impact matter

---



# Inspiration

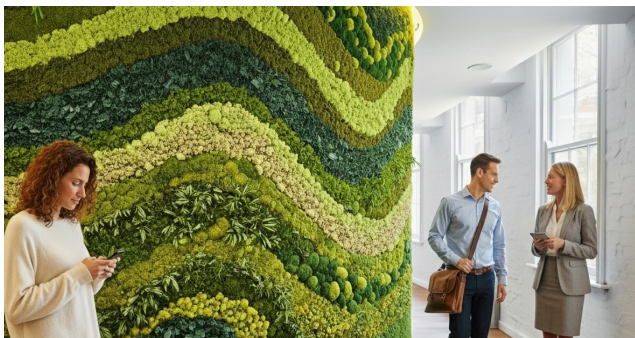



## Dimensions

### Standard Unit Dimensions

Typical ranges for height and width.

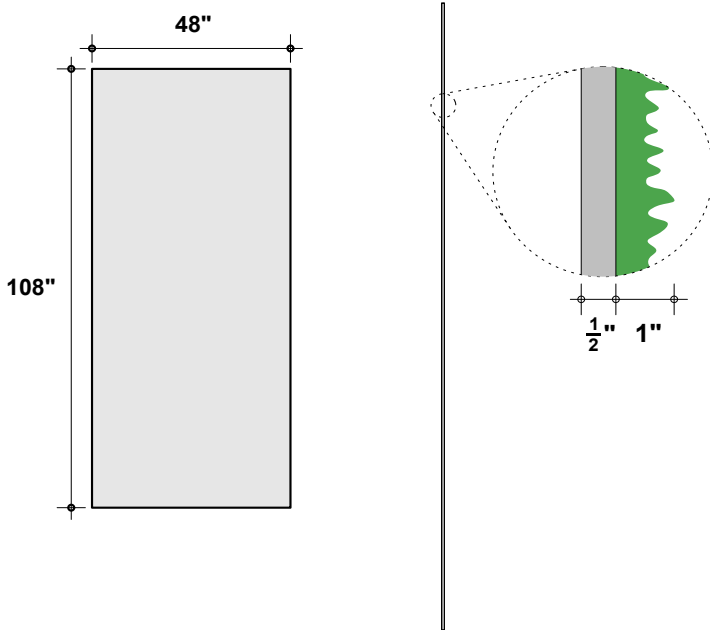

### Custom Opportunity

Product dimensions can be manipulated in order to fit your design aesthetic and site conditions.

### Standard Unit Thicknesses

Thickness is dependent on material layer selection.



## Material Options

The layouts shown are a summation of individual units. Individual units may be assembled in various arrangements to dictate the larger design. Configurations shown are suggested, but can be rearranged to achieve a custom layout.

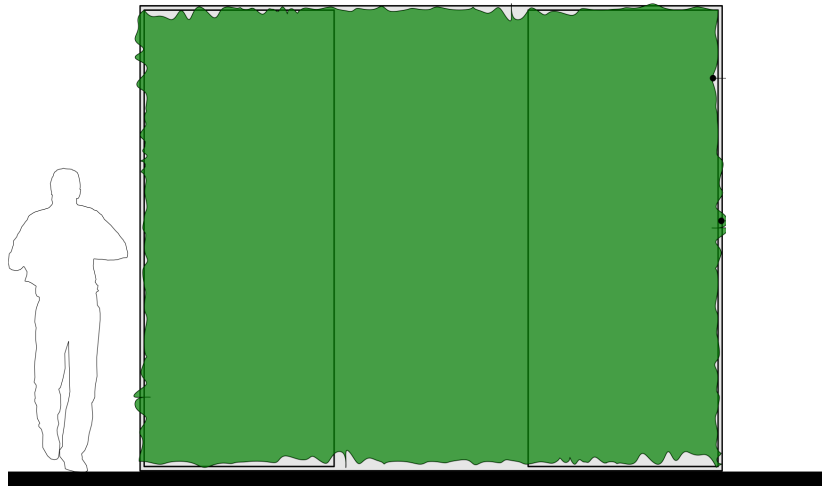

**Reindeer Moss**  
1"-1.5" Depth



**Mood Moss**  
2"-3" Depth



**Sheet Moss**  
1"-1.25" Depth



**Pole Moss**  
2"-2.25" Depth

## Backer Options

### Soundcore®

Our recycled PET felt creates an acoustic barrier, defending against wandering white noise and irritating echoes.

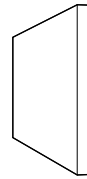

**Single Layer**  
½" Thickness

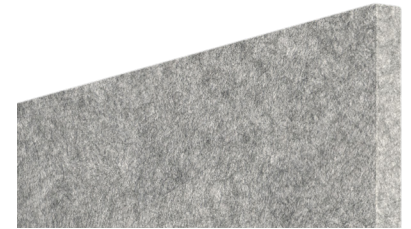

### Wood treated plywood 1/2"

Ideal for recessed wall opportunities & and Pre-Manufacture Solutions



**Single Layer**  
½" Thickness



## Design Options

The layouts shown are a summation of individual units. Individual units may be assembled in various arrangements to dictate the larger design. Configurations shown are suggested, but can be rearranged to achieve a custom layout.

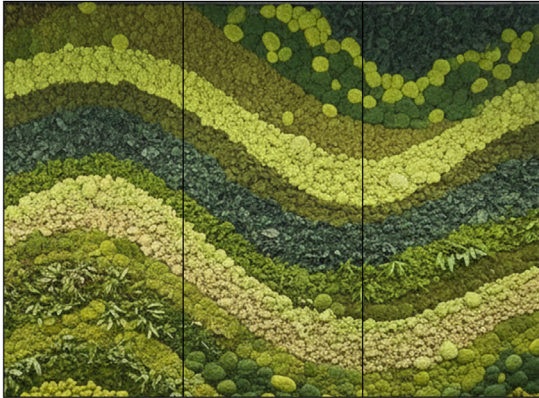

Wave



Surge

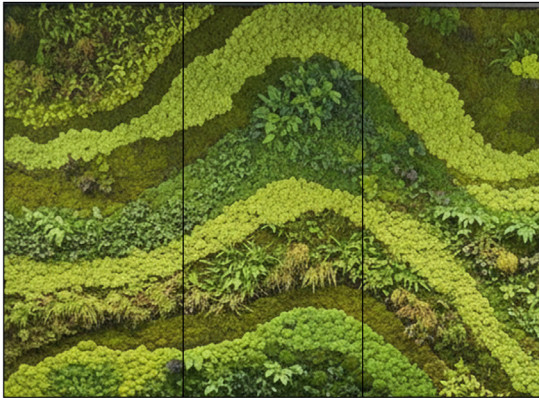

Rebound

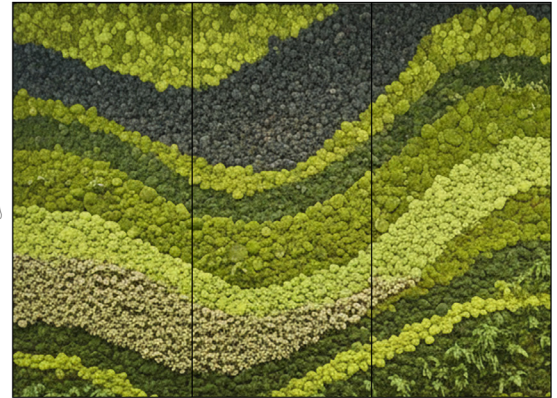

Bounce

## Design Options + cost

The layouts shown are a summation of individual units. Individual units may be assembled in various arrangements to dictate the larger design. Configurations shown are suggested, but can be rearranged to achieve a custom layout.

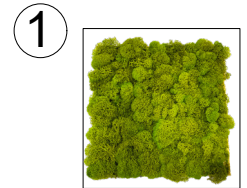
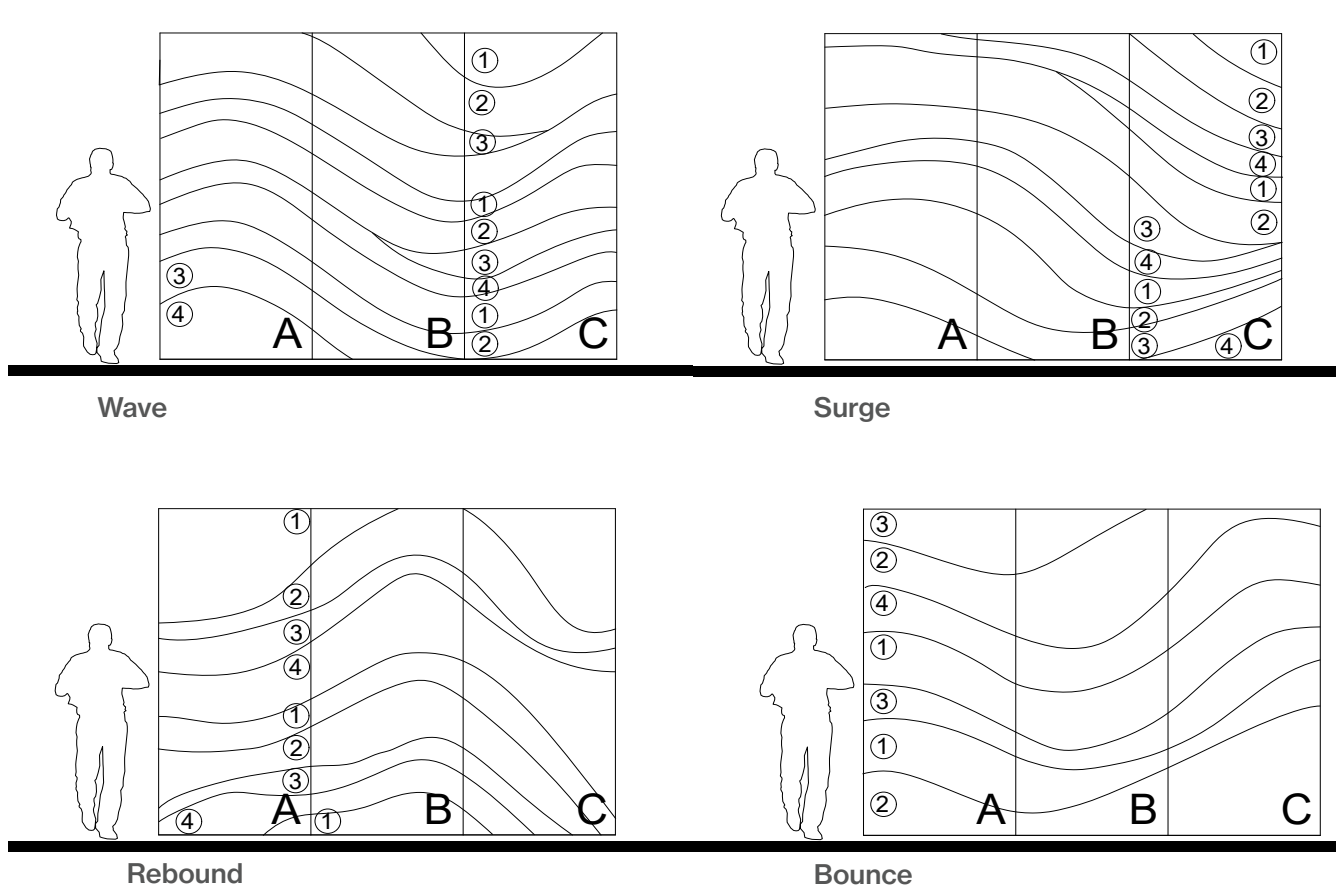

Reindeer Moss

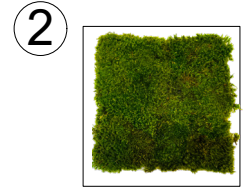

Mood Moss

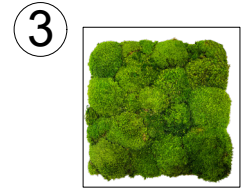

Pole Moss

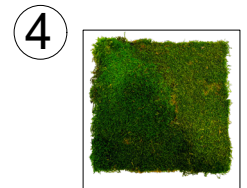

Sheet Moss

## Panel Configuration Options

The layouts shown are a summation of individual units. Individual units may be assembled in various arrangements to dictate the larger design. Configurations shown are suggested, but can be rearranged to achieve a custom layout.

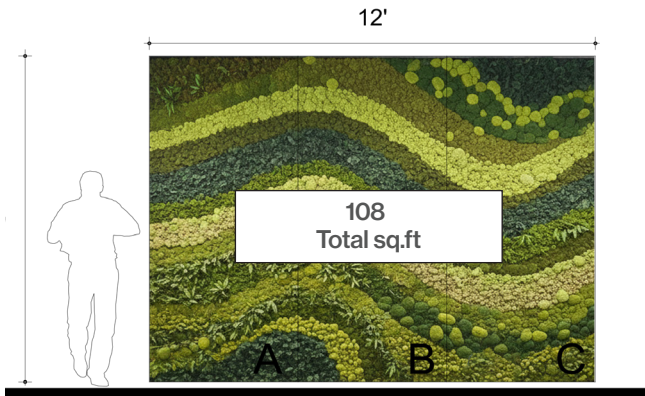

Full Panel Integration

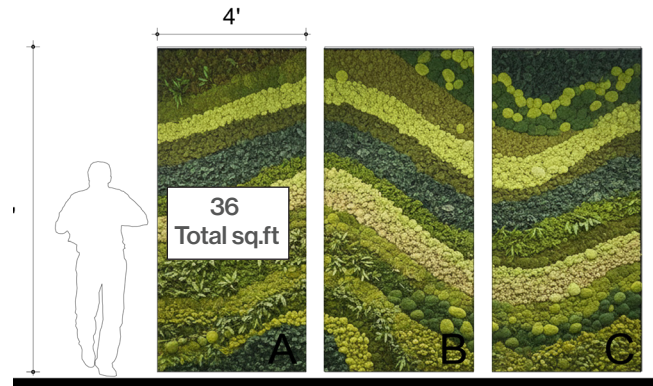

Individual Panel Coverage

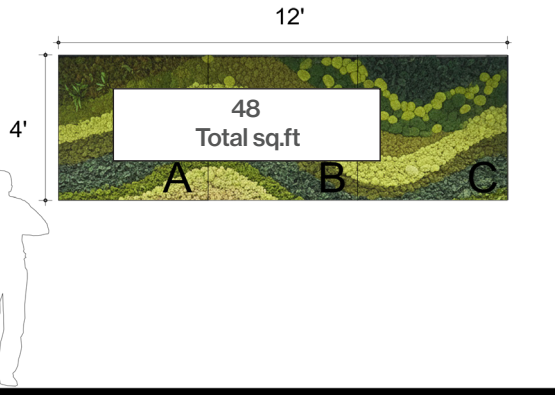

Upper Wall Option

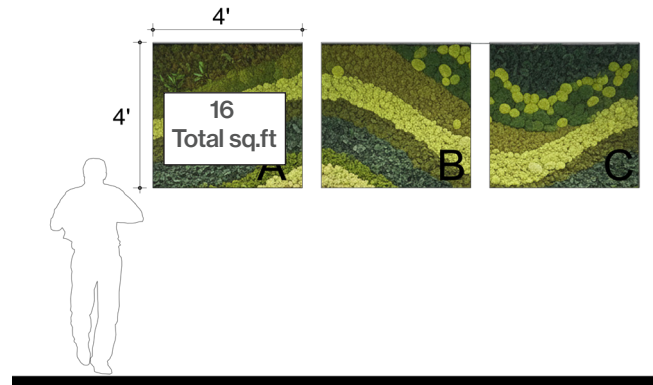

Upper Wall Individual Option

## Installation Options\*

All products and installation methods can be **customized** to meet the unique requirements of your space.

### Adhesive Direct Advantages

Attachment solution using an adhesive to apply directly to an existing surface or substrate.

- + Fastest installation time
- + No gap between target surface and product
- + Lowest profile installation option
- + Easiest to install
- + Most versatile installation option

Available methods: Construction Adhesive, Peel & Stick, Custom

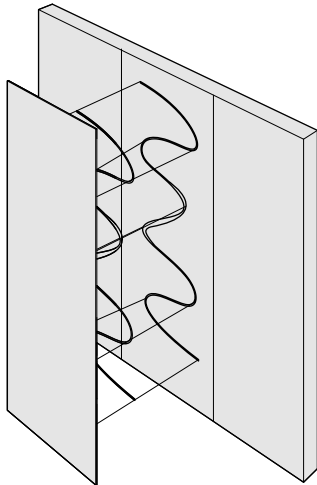

### Mechanical Direct Advantages

Attachment solution using physical hardware to attach to an existing surface or substrate.

- + No clamping or dry time necessary
- + Easy to remove and does not damage the substrate when removed
- + Most appropriate installation solution for heavier products
- + Provides an opportunity for an air gap, which can increase the acoustic value of a product

Available methods: Z-Clips, Panel Clips, Standoffs, Screw & Washer, Magnet, Custom

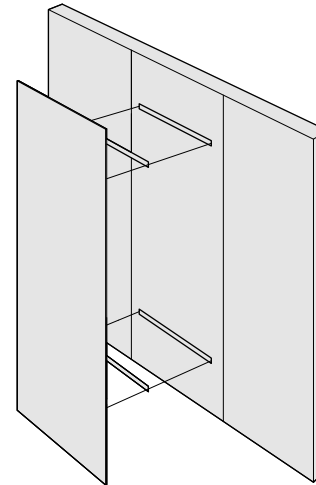

\*Not all listed attachment methods may be applicable to this product.

Soundcore® Backer | 1/2"



**SND130**  
Buckskin

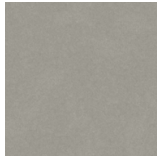

**SND131**  
Abalone



**SND125**  
Chinchilla

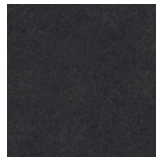

**SND103**  
Storm Cloud



**SND038**  
Inkwell

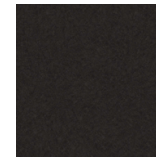

**SND122**  
Briquette

Preserved Reindeer Moss Color Selection



**Light Green**  
PMC#RD01LG



**Medium Green**  
PMC#RD01MG



**Nature Green**  
PMC#RD01NG



**Forest Green**  
PMC#RD01FG



**Lime Green**  
PMC#RD01LG



**Cream**  
PMC#RD01CR



**Black**  
PMC#RD01BK



**Purple**  
PMC#RD01PR



**Fuchsia**  
PMC#RD01FS



**Red**  
PMC#RD01RD



**Orange**  
PMC#RD01OR



**Yellow**  
PMC#RD01YW



**Royal Blue**  
PMC#RD01RB

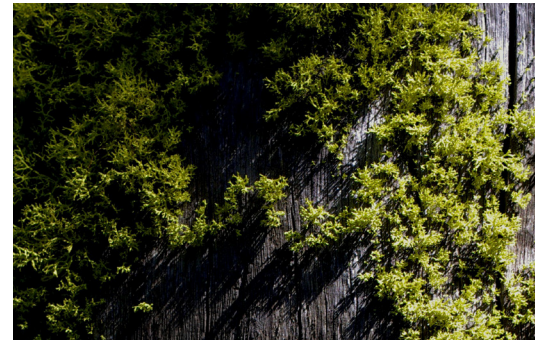

## Why Moss?

Being surrounded by moss evokes the feeling of walking through a misty Rainforest enveloped by trees. Its velvety texture blanketing the forest floor creates a comforting environment. Incorporating biophilic design by including moss into interior spaces creates a bridge between the natural and built world.